

# FRONT ROW

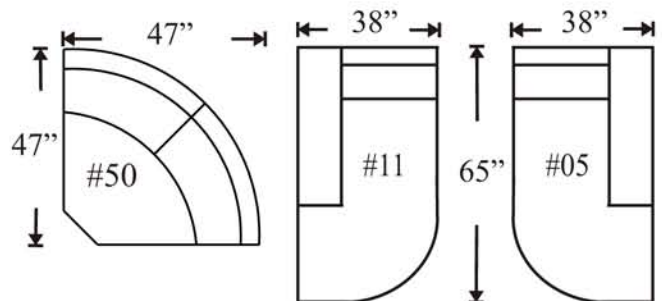

# Melbourne

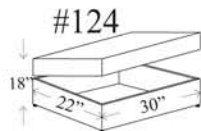
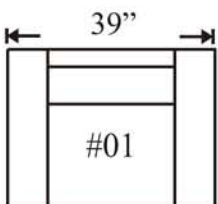
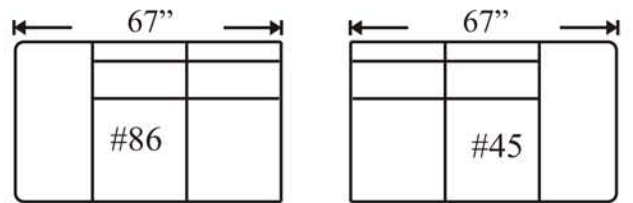
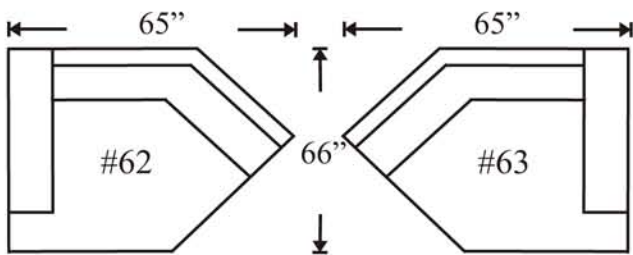
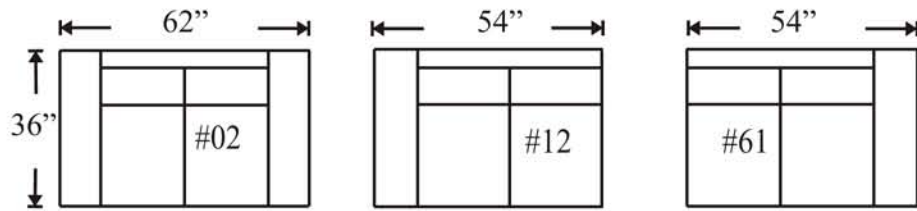
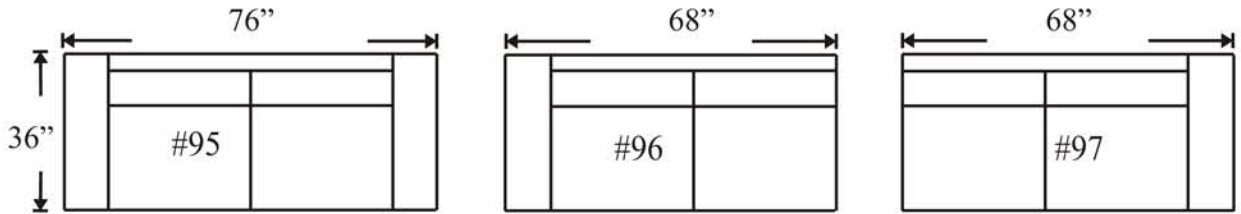

# FRONT ROW



# Melbourne

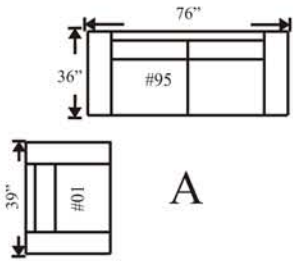

A

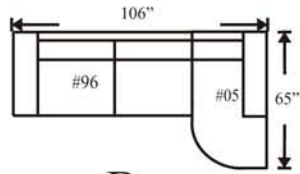

B

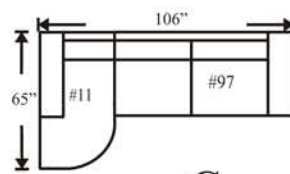

C

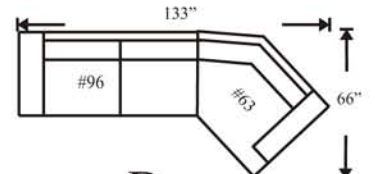

D

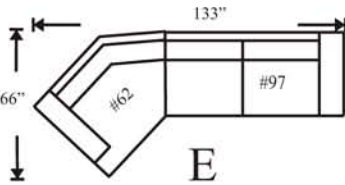

E

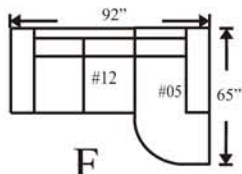

F

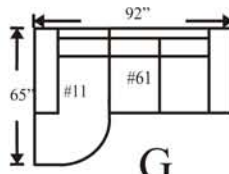

G

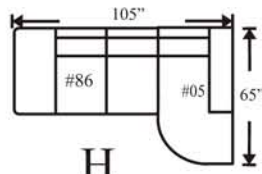

H

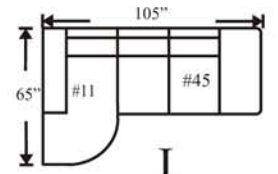

I

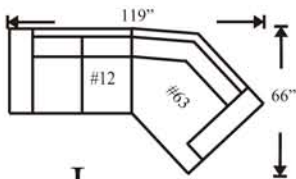

J

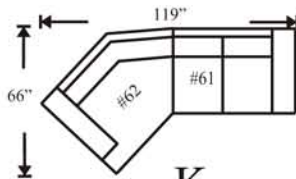

K

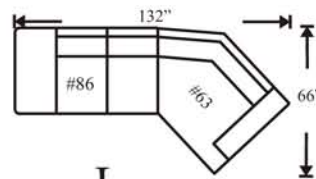

L

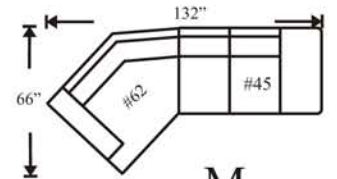

M

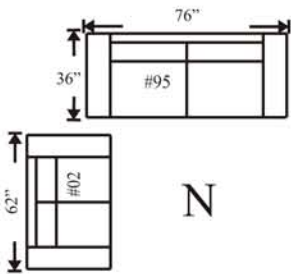

N

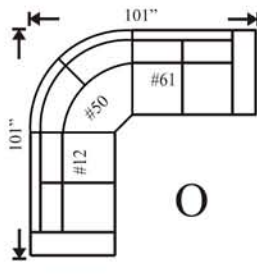

O

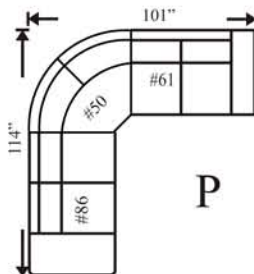

P

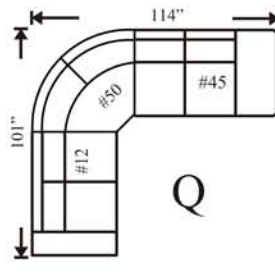

Q

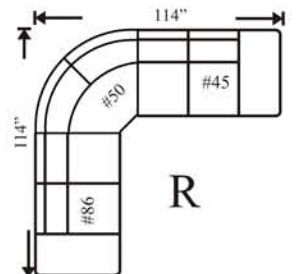

R

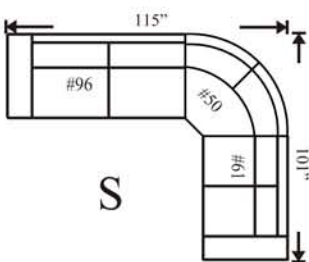

S

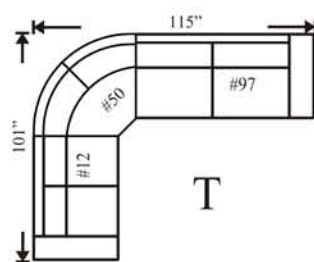

T

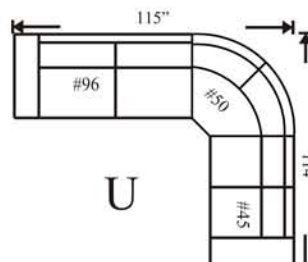

U

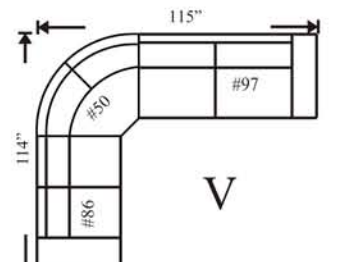

V